

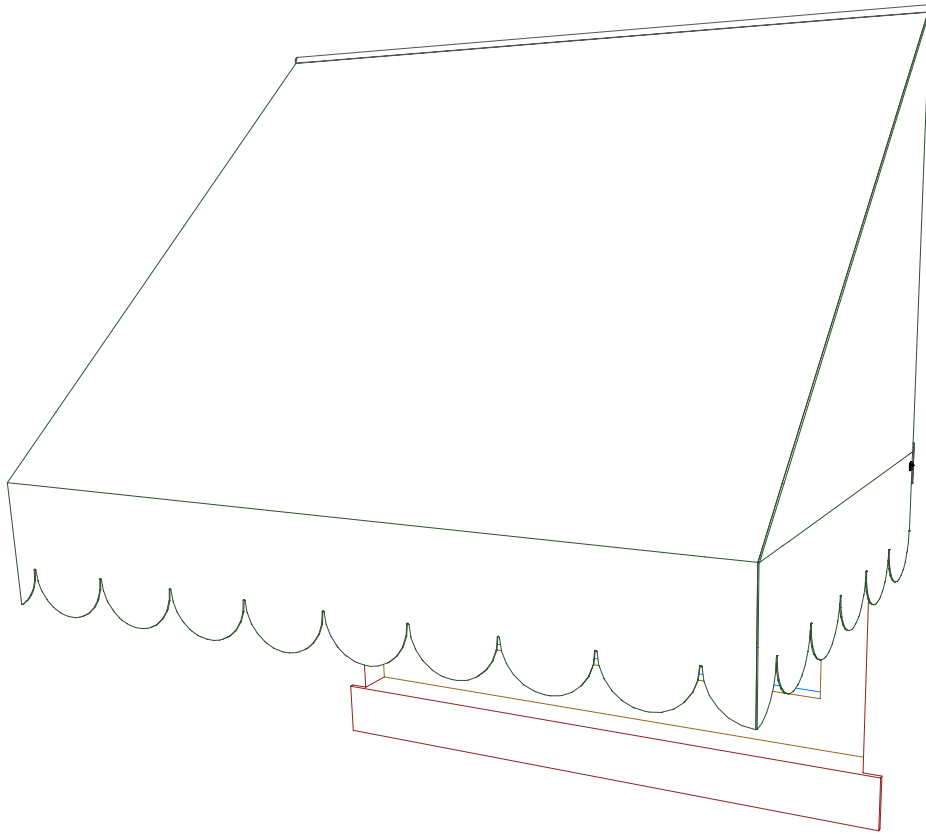

Contact us @ (800)851-0865

RAINBO AWNING with SIDES ASSEMBLY INSTRUCTIONS



Recommended Tools:

Screw Driver
Pliers
Tape Measure
Carpenters Level

(If Awning is being Attached to Brick or Masonry a Drill,
Masonry Bit, and Masonry Anchors are Required)

Not Included

For Ease of Assembly and Installation

- Familiarize yourself with component parts

Rec'd - 11/01/05

NOTE: The number of parts needed for installation will vary on the size of the awning.

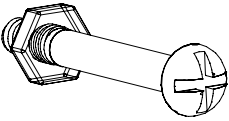
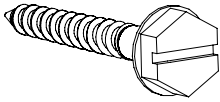
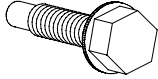
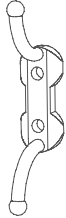
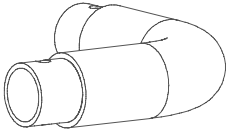
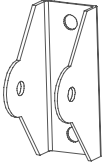
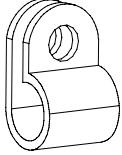
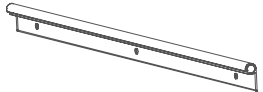
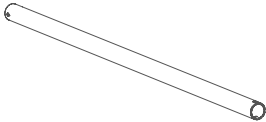
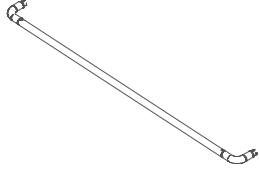
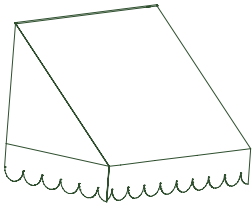
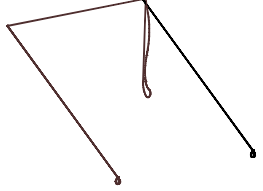
 <p>1. 1 1/4" Bolt & Nut</p>	 <p>2. 1" Screw</p>	 <p>3. 5/8" Self Tapping Tek Screw</p>	 <p>4. Rope Cleat</p>
 <p>5. Plastic Elbow</p>	 <p>6. Wall Hinge</p>	 <p>7. Rope Guide</p>	 <p>8. Mounting Strip</p>
 <p>9. Return Arm</p>	 <p>10. Front Cross Tube (w/ Elbows)</p>	 <p>11. Awning Fabric</p>	 <p>12. Rope</p>

STEP 1.

Slide the front cross tube through sewn pocket in the front of the awning fabric (see Fig 1-1). Attach return arms to elbows using 5/8" self tapping Tek screws (see Fig 1-2).

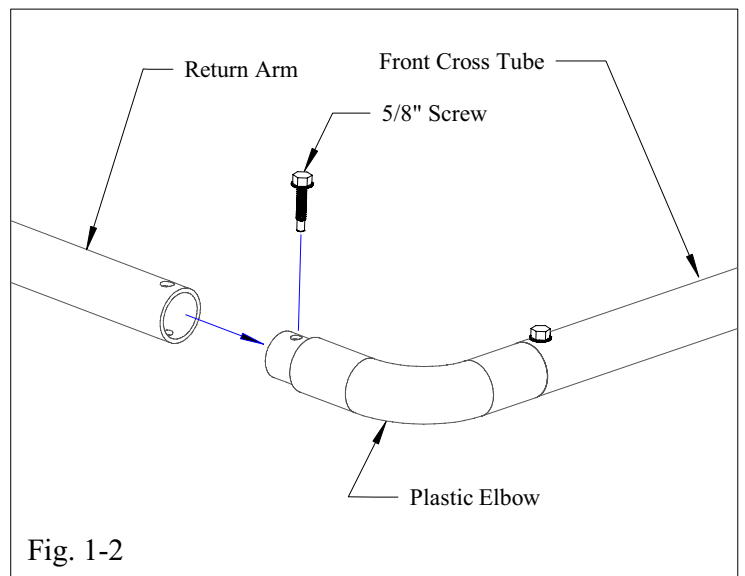
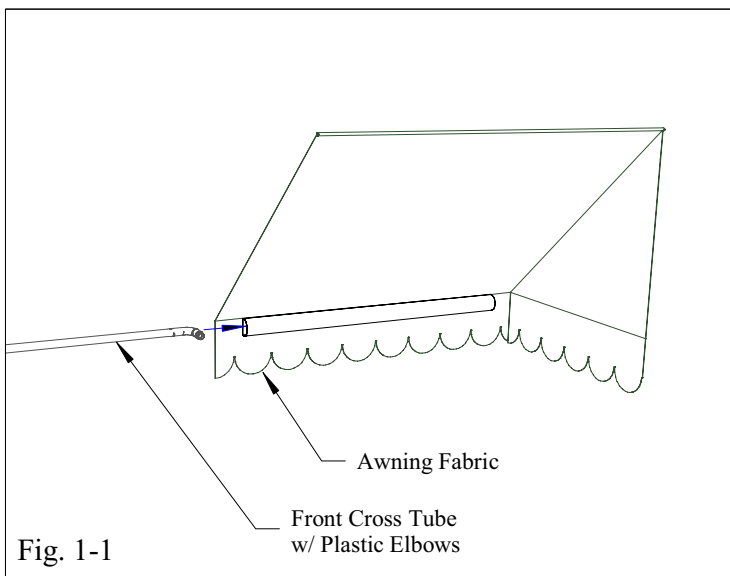

STEP 2.

Center mounting strip above window. Mark position of holes with a pencil. "Starter" holes are recommended using a drill or awl. Fasten mounting strip and rope guides with 1" screws. (Drill with masonry bit and masonry anchors are required for fastening to brick or masonry.)

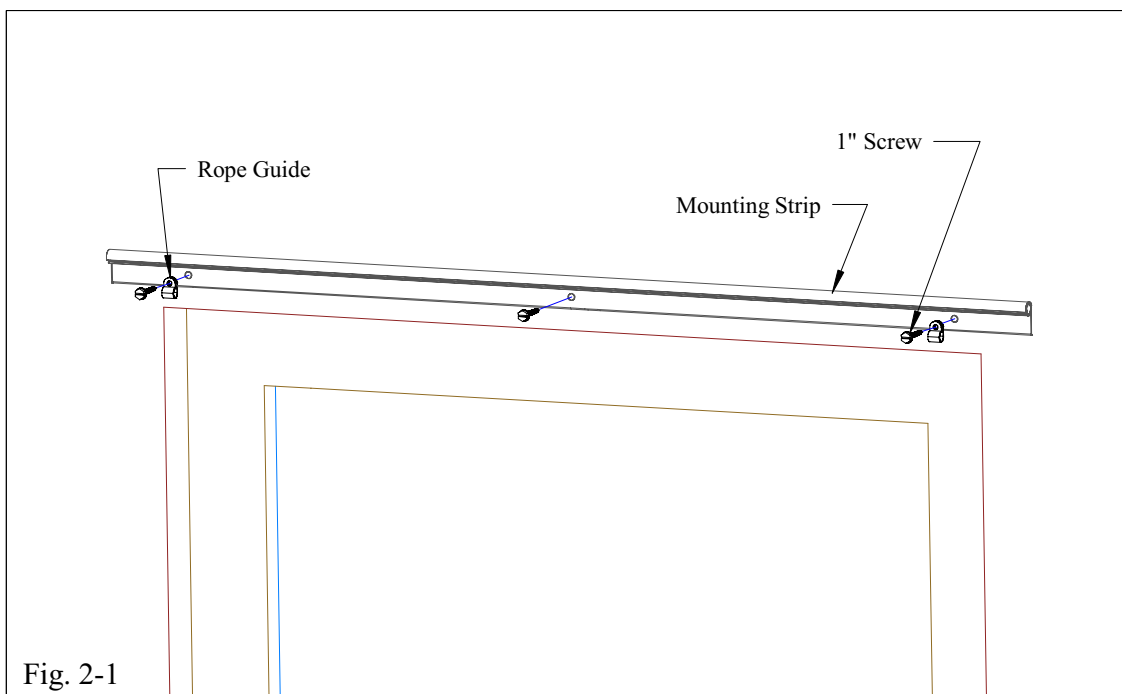

STEP 3.

Slide awning fabric into mounting strip channel (see Fig 3-1). Awning frame assembly should be on underside of the fabric toward the window.

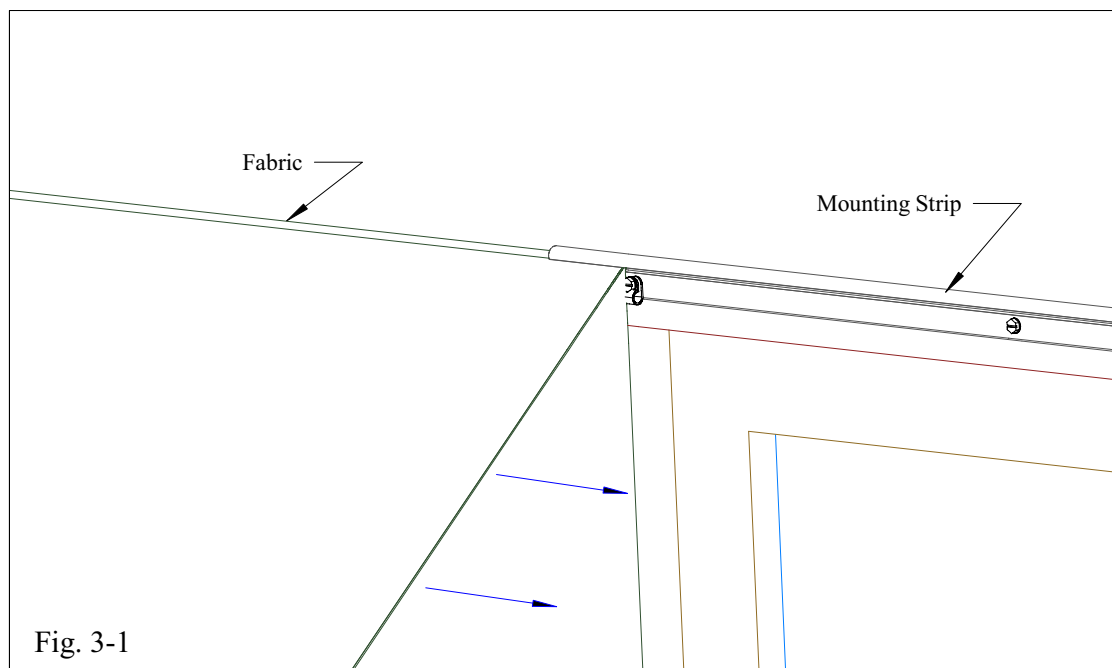

STEP 4.

Place wall hinges against frame or wall in level position. Mark position of holes. On most windows the assembly should be halfway down the window (see Fig 4-1). If satisfactory, fasten to wall with 1" screws. Then attach return arms to wall brackets through the grommet in the fabric with a 1 1/4" bolt & nut (see Fig 4-2).

Note: Different fasteners required if attaching to brick or masonry).

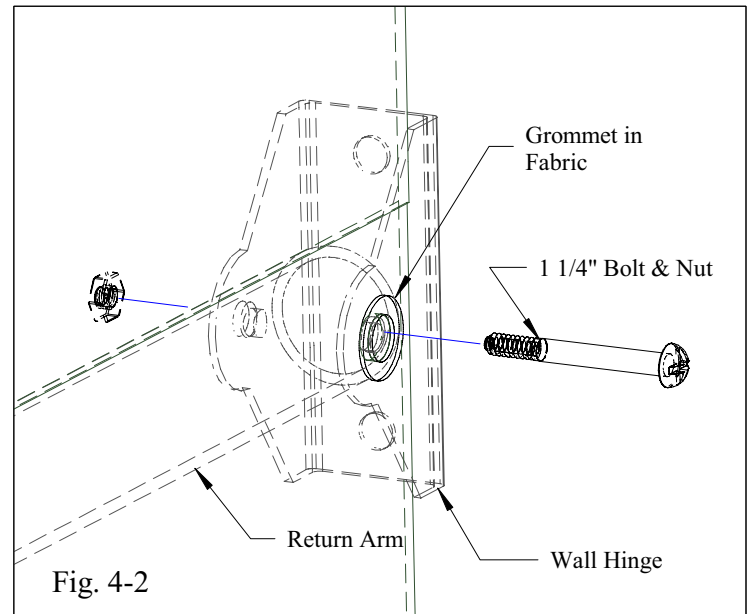
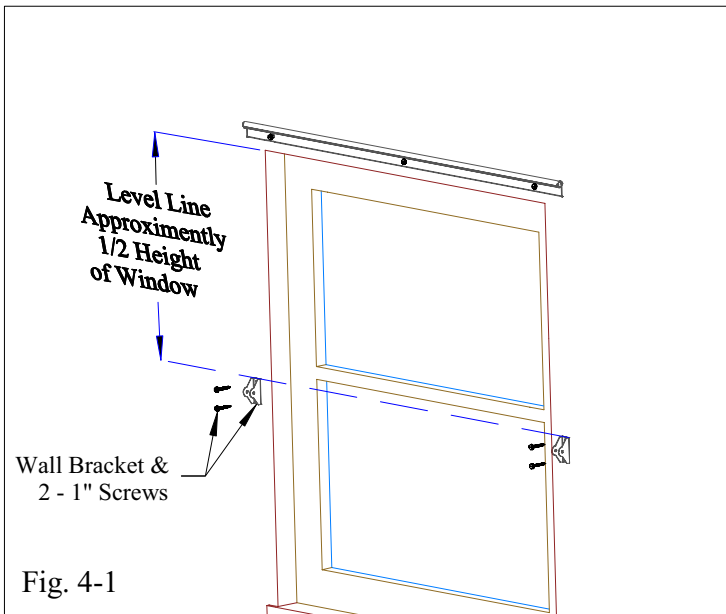

STEP 5.

Thread rope through rope guide (see Fig 5-1). Tie ends to the front corner where the plastic elbow and front cross tube join. Pull rope downward and determine best spot for rope cleat and attach with 1" screw (see Fig. 5-2)

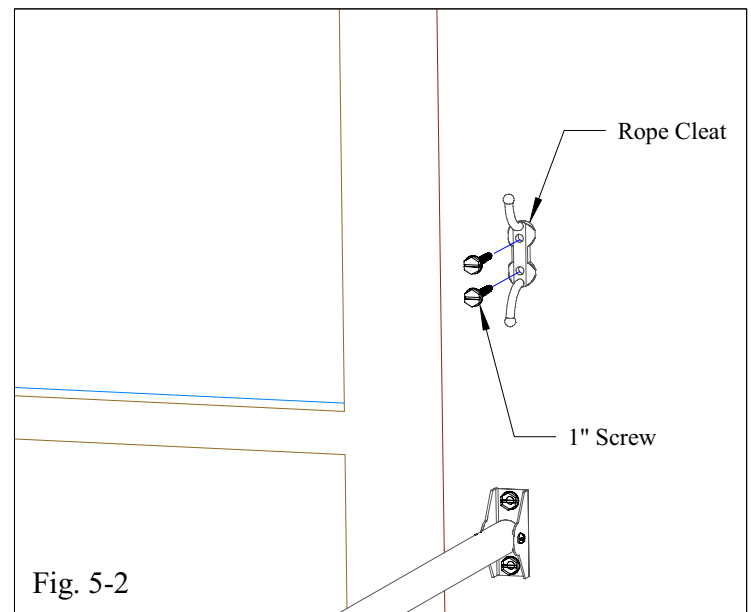
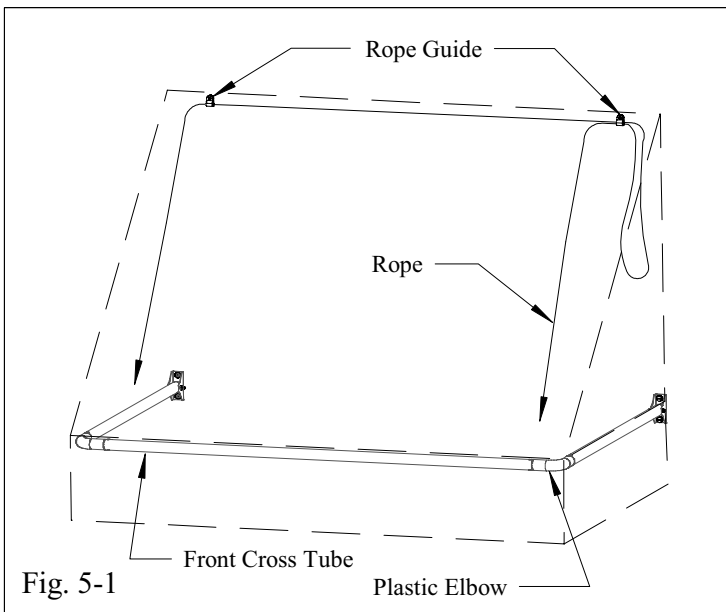

ASSEMBLY COMPLETED