

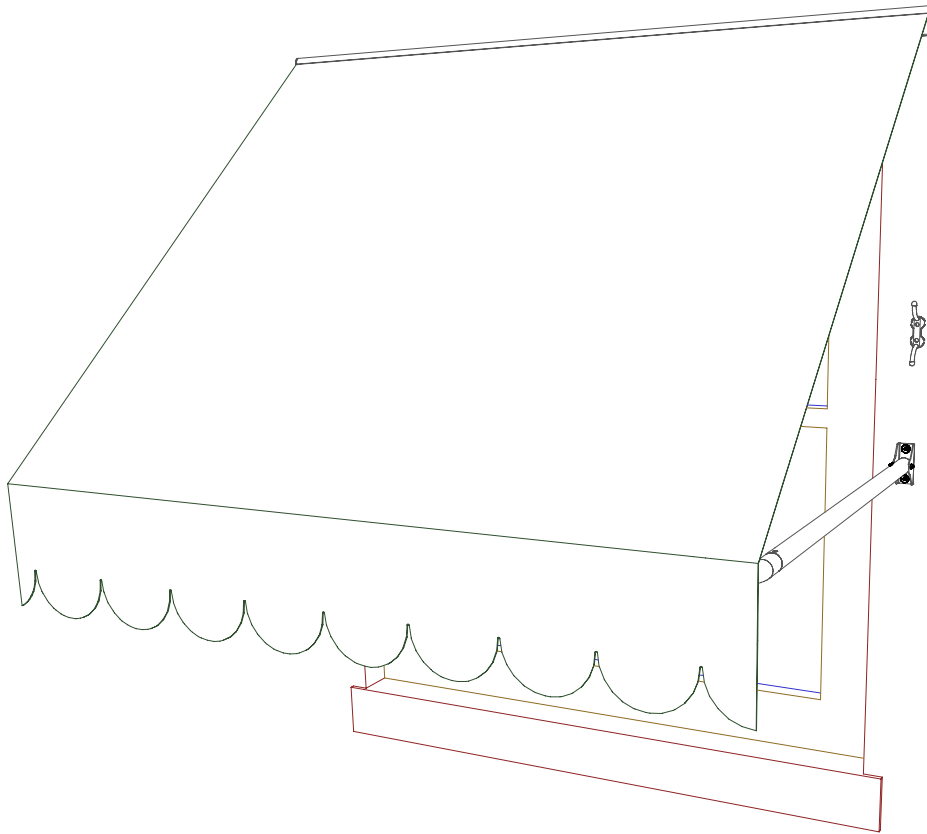

Contact us @ (800)851-0865

# RAINBO AWNING w/o SIDES ASSEMBLY INSTRUCTIONS



### ***Recommended Tools:***

Screw Driver  
Pliers  
Tape Measure  
Carpenters Level

(If Awning is being Attached to Brick or Masonry a Drill,  
Masonry Bit, and Masonry Anchors are Required)

*Not Included*

### ***For Ease of Assembly and Installation***

- Familiarize yourself with component parts

Rev'd - 11/01/05

## AWNING PARTS LIST

NOTE: The number of parts needed for installation will vary on the size of the awning.

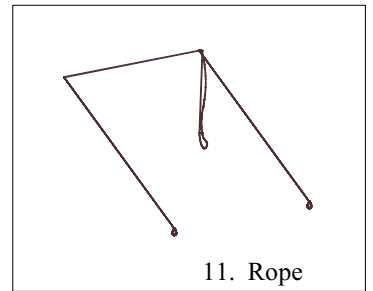
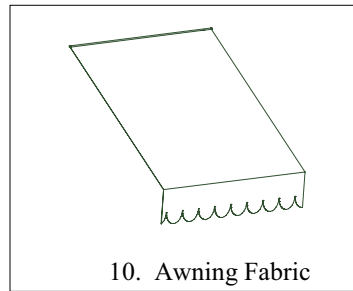
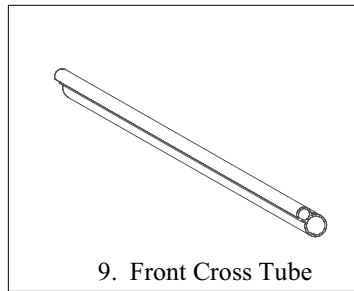
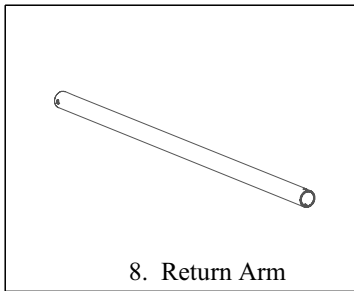
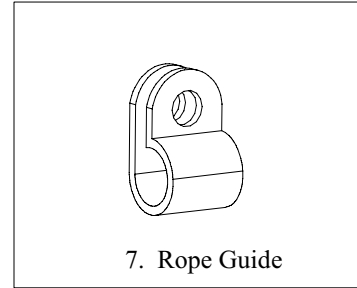
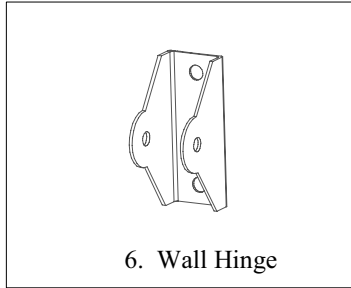
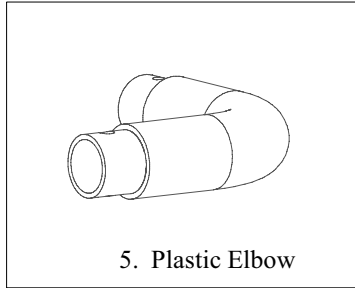
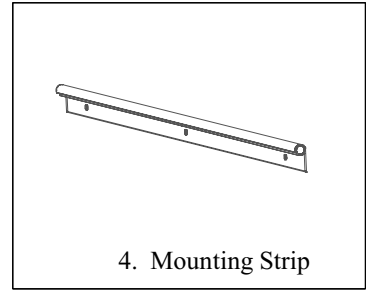
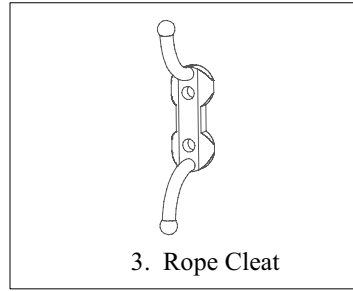
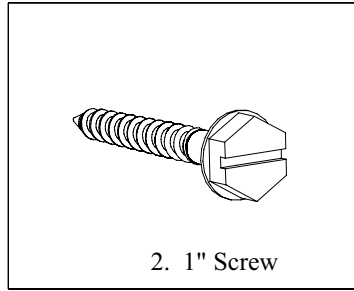
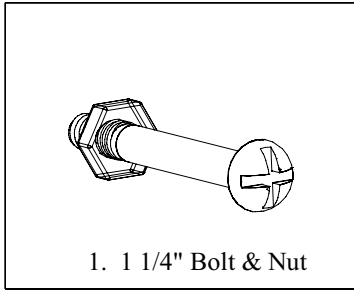

### **STEP 1.**

Attach wall hinges to arms using 1 1/4" bolt and nut (see Fig 1-1).

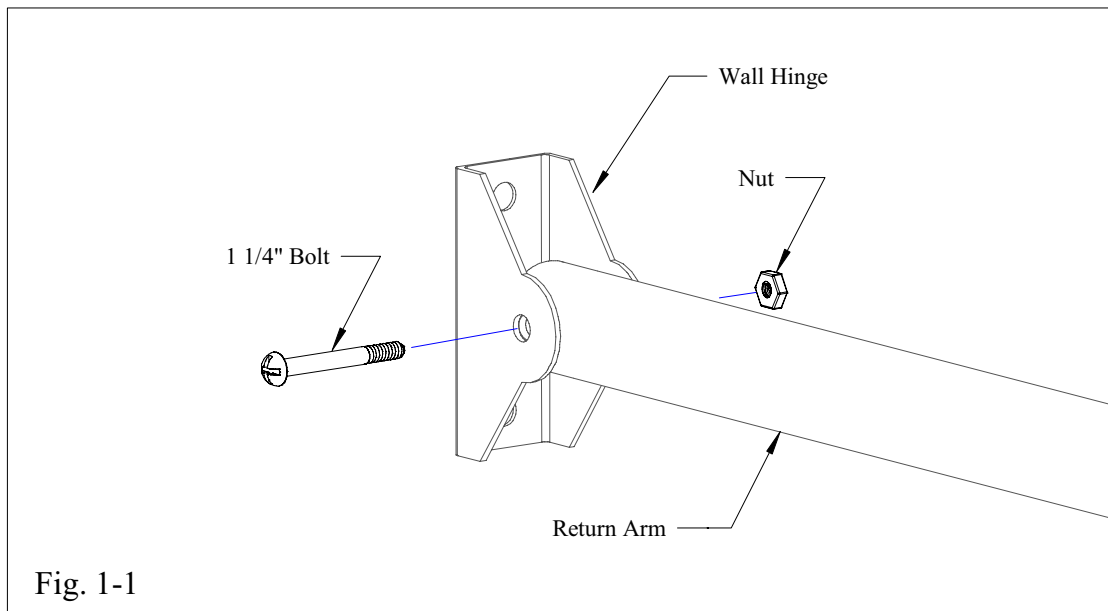

## **STEP 2.**

Center mounting strip above window. Mark position of holes with a pencil. "Starter" holes are recommended using a drill or awl. Fasten mounting strip and rope guides with 1" screws. (Drill with masonry bit and masonry anchors are required for fastening to brick or masonry.)

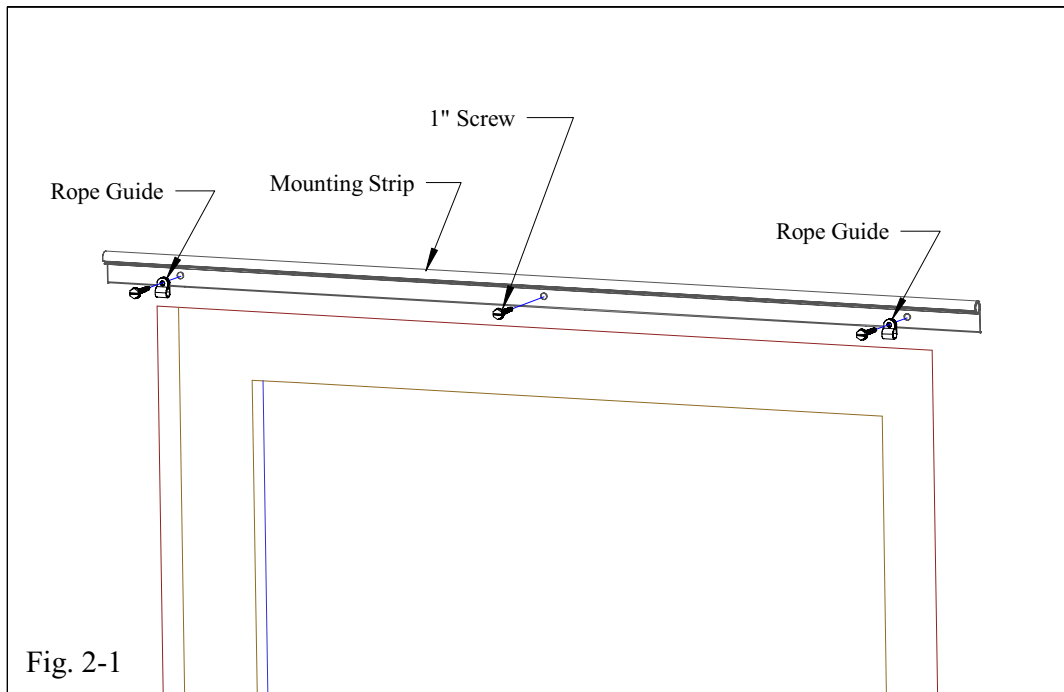

## **STEP 3.**

Slide awning fabric into mounting strip channel (see Fig 3-1). Awning frame assembly should be on underside of the fabric toward the window.

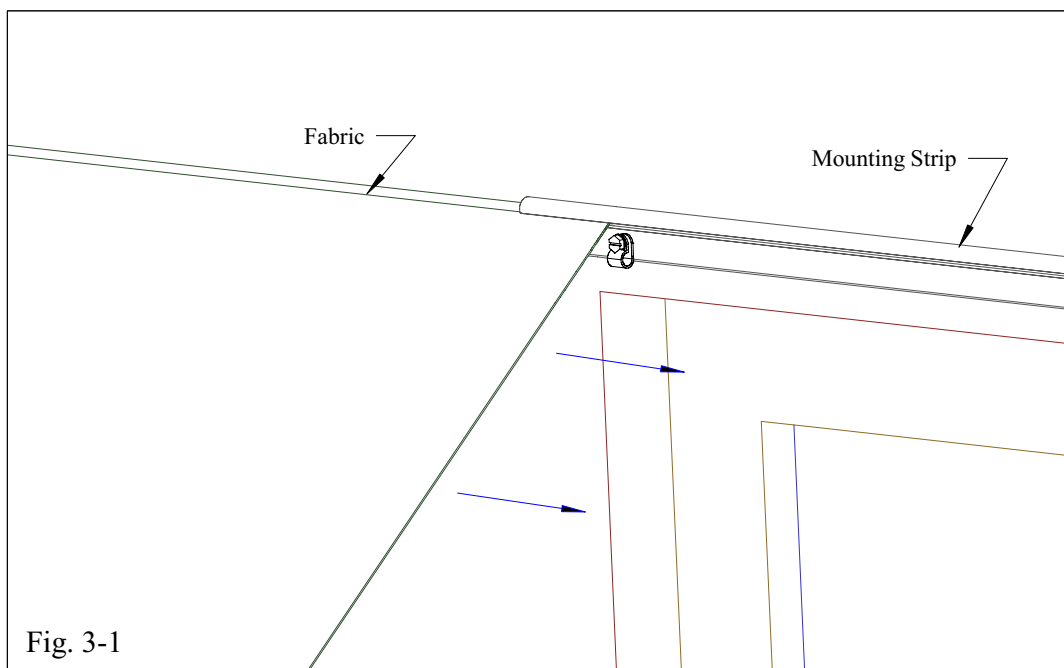

## **STEP 4.**

Place return arm & wall hinges against frame or wall in level position. Mark position of holes. On most windows the assembly should be halfway down the window (see Fig 4-1). If satisfactory, fasten to wall with 1" screws (see Fig 4-2).

Note: Different fasteners required if attaching to brick or masonry).

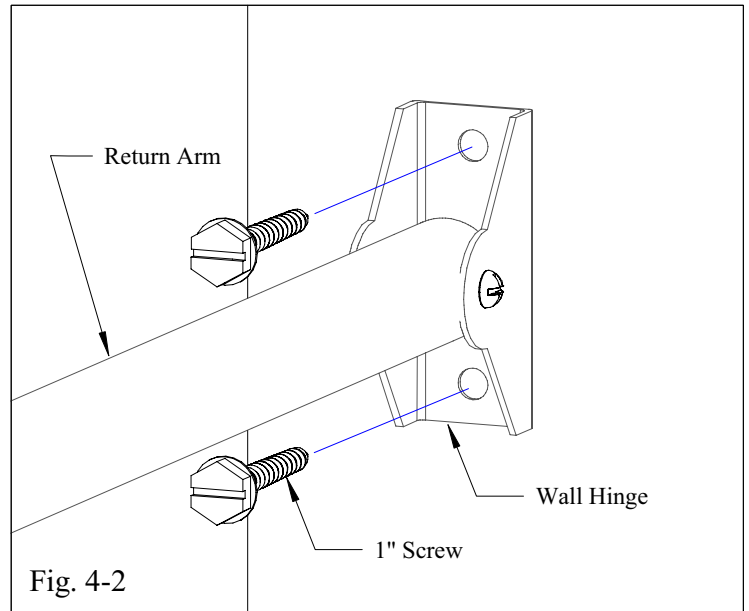
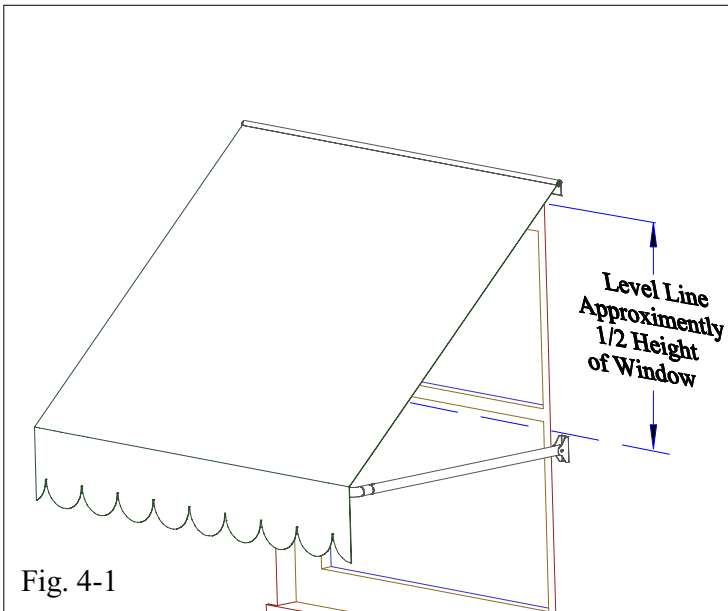

## **STEP 5.**

Thread rope through rope guide (see Fig 5-1). Tie ends to the front corner where the plastic elbow and front cross tube join. Pull rope downward and determine best spot for rope cleat and attach with 1" screw (see Fig. 5-2)

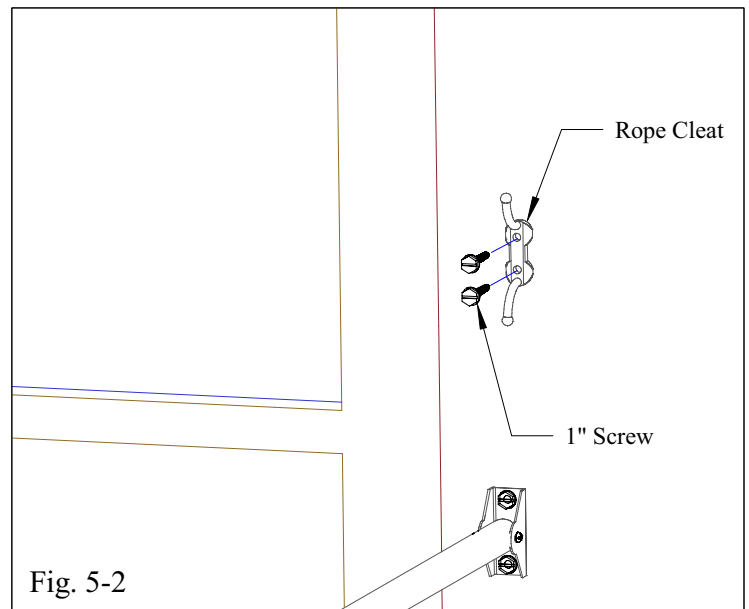
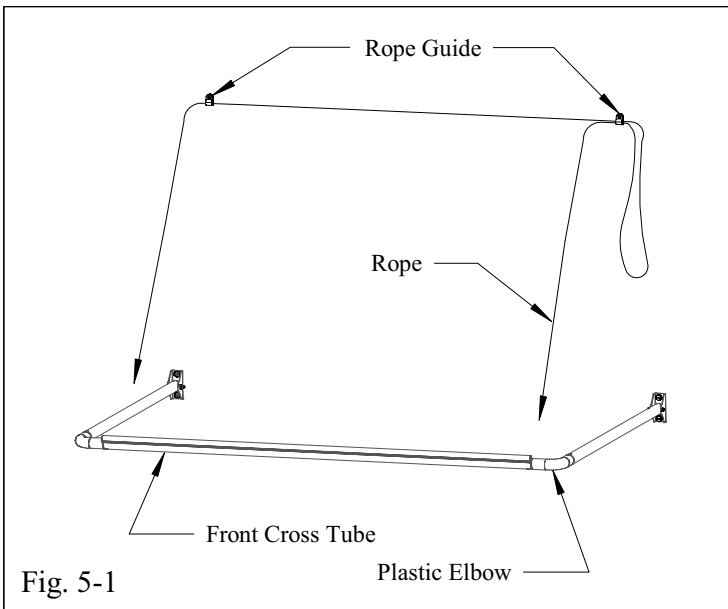

## **ASSEMBLY COMPLETED**

Other Products Available from Americana: Aluminum Awnings - Carports - Patio Covers - Room Enclosures - Park Shelters  
Check Out Our Web Site @ [www.americana.com](http://www.americana.com)